

"MOBİLİS ELITE" BARA SİSTEMİNİ OLUŞTURAN PARÇALAR

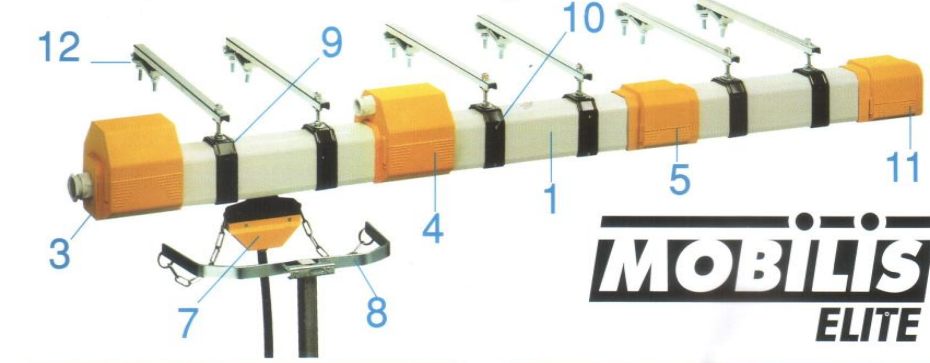

MOBİLİS ELITE

1. BARA ELEMANI

2. GENLEŞME ELEMANI

Yanmaz PVC
Standart boylar 4m, 2m, 1m
İsteğe bağlı özel boy
Referans numaraları aşağıdadır.

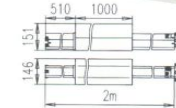

100m'den daha uzun hatlarda sistemin ortasında kullanılır.
IP23

Bestell-Nr hier unten

Güç	20A		40A		60A		100A		130A		200A	
İletken malzeme	Çelik 16 mm ²		Bakır 10 mm ²		Bakır 16 mm ²		Bakır 24 mm ²		Bakır 35 mm ²		Bakır 70 mm ²	
50Hz'de empedans	0,0116 Ohm/m		0,0017 Ohm/m		0,0012 Ohm/m		0,00077 Ohm/m		0,00056 Ohm/m		0,00031 Ohm/m	
Kutup sayısı	4	5	4	5	4	5	4	5	4	5	4	5
Ağırlık (kg/m)	1,7	1,8	1,5	1,6	1,8	1,9	2,0	2,1	2,4	2,7	3,7	4,2
Boy 4 m	ME4204	ME5204	ME4404	ME5404	ME4604	ME5604	ME4104	ME5104	ME4134	ME5134	ME8284	ME8285
Boy 2 m	ME4202	ME5202	ME4402	ME5402	ME4602	ME5602	ME4102	ME5102	ME4132	ME5132	ME8282	ME8286
Boy 1 m	ME4201	ME5201	ME4401	ME5401	ME4601	ME5601	ME4101	ME5101	ME4131	ME5131	ME8281	ME8287
Özel boy	ME4200	ME5200	ME4400	ME5400	ME4600	ME5600	ME4100	ME5100	ME4130	ME5130	ME8280	ME8288
Genleşme elemanı	ME8020	ME8520	ME8040	ME8540	ME8060	ME8560	ME8100	ME8510	ME8013	ME8513	ME8290	ME8291

3. THERMOPLASTİK PG21/29/36



Thermoplastik
Yanmaz
IP 23
Güçler
20, 40, 60,
100A

Altın rekor olanı: 35 mm
Ağırlık 0,4 kg

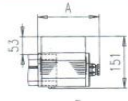

	Boyut A	Boyut B	Referanslar	Kablo ø
PG21	181	126	ME 1200	12 bis 18 mm
PG29	183	128	ME 1230	16 bis 24 mm
PG36	187	132	ME 1250	22 bis 30 mm

4. ORTADAN BESLEME KUTUSU PG36



IP23
Kablo ø 22 bis 30 mm
Ağırlık 1,5 kg
Referanslar : (4P) ME1332 - (5P) ME1329

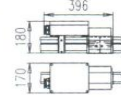

4. ORTADAN BESLEME KUTUSU PG21/29



Thermoplastik yanmaz IP 23
Güçler 20, 40, 60, 100A
Ağırlık 0,3 kg

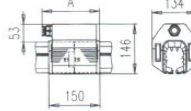

	Boyut A	Referanslar	Kablo ø
PG21	169	ME 1300	12 bis 18 mm
PG29	171	ME 1330	16 bis 24 mm

5. ÖRTÜ ELEMANI



Thermoplastik yanmaz
IP 23
Ağırlık 0,2 kg
Referanslar : ME1000

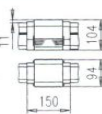

6. BESLEME ELEMANI 130A VE 200A



1m bara elemanı üzerine montajı olarak
IP23 - Ağırlık ~ 10 kg (Bu ağırlığa 2 metrelik bağlantı kabloları dahildir)
2 tutucu kullanın

Güç	4 Kutuplu	5 Kutuplu	4 veya 5 Kablo Ø	Kesit	Boyut A
130A	ME1313	ME1317	10,5 mm	35 mm ²	170
200A	ME8299	ME8294	14,4 mm	70 mm ²	220

7. KUTULU TEK FIRÇA



Yanmaz
Nom. Güç 40A
Esnek kablo ile bağlantı
Terminal 6mm²
Ağırlık 0,6 kg

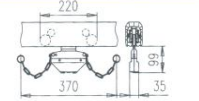

Referanslar : (4P) ME3043
(5P) ME3051

7. KUTULU ÇİFT FIRÇA



Nom. Güç 80A
2 Esnek kablo ile bağlantı
Terminal 6mm²
Ağırlık 1,2 kg

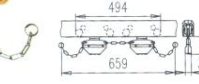

Referanslar : (4P) ME4042
(5P) ME4050

FIRÇALARIN SABİT KULLANIMI

Tekli fırça	Çiftli fırça	Üçlü fırça
40'de 40 sn.	80'de 40 sn.	120A'de 40 sn.
30A'de 5 dk.	60A'de 5 dk.	90A'de 5 dk.
20A'de 30 dk.	40A'de 30 dk.	60A'de 30 dk.
16A'de 24 s.	32A'de 24 s.	48A'de 24 s.

9. KAYAR TUTUCU



Kaplamalı çelik
M8x60 vida motaj edilmiş
20A'den 130A'e kadar : Bir 4m bara elemanı için 2adet
Güç 200A : 3'e kadar 4m Elemanı
Ağırlık 0,1 kg
Referanslar : ME1110

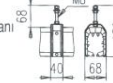

10. SABİT TUTUCU



Kaplamalı çelik komple montajı
4 adet bağlantı vidasıyla gönderilir
Ağırlık 0,1 kg
Referanslar : ME1100

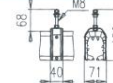

11. SON KAPAK



Yanmaz termoplastik
IP23
Ağırlık 0,7 kg
Referanslar : ME1400

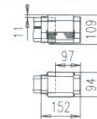

7. KABLOLU TEK FIRÇA



Yanmaz
Nom. Güç 40A
Bağlantı kablosu 4 x 4 mm² veya
5 x 4 mm² - Boy 1m

Ağırlık 1,1 kg
Referanslar : (4P) ME2043
(5P) ME2051

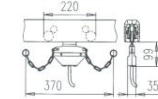

7. KUTULU ÜÇLÜ FIRÇA



Nom. Güç 120A
3 Esnek kablo ile bağlantı
Terminal 6mm²
Ağırlık 1,8 kg
Referanslar : (4P) ME5040
(5P) ME5050

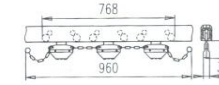

8. FIRÇA TAŞIYICI



20 ile 50 mm arası kare profile bağlantı.
Hareket toleransı : Yatay +/- 50 mm, Düşey +/- 50 mm

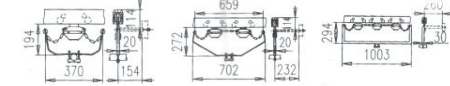

Tekli fırça için tekli taşıyıcı
Tekli fırça
Ağırlık 0,6 kg
Referanslar : ME1600

Çiftli fırça için çiftli taşıyıcı
Çiftli fırça
Ağırlık 1,1 kg
Referanslar : ME1610

Üçlü fırça için üçlü taşıyıcı
Ağırlık 2,6 kg
Referanslar : ME1630

8. KUTULU TAŞIYICI

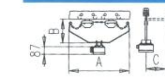

Çiftli fırçanın 5x16 mm² kablo ile bağlantısı için
Üçlü fırçanın 5x25mm² kablo ile bağlantısı için

Tip	Referanslar	A	B	C	Ağırlık
Çiftli	(4P) ME1640 (5P) ME1645	702	272	232	2 kg
Üçlü	(4P) ME1650 (5P) ME1655	1003	294	260	4 kg

12. ASKI KOLU



Galvanizli çelik
200 A için lütfen yalnızca ME1760 ve ME1780 kullanınız

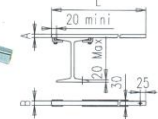

Referanslar	Özel boy	Kesit A x B	Ağırlık
ME1700	380 mm	15 x 20 mm	0,55 kg
ME1750	500 mm	15 x 20 mm	0,60 kg
ME1760	600 mm	30 x 30 mm	0,95 kg
ME1780	850 mm	30 x 30 mm	1,20 kg